

Power Inductor SMD (6.8 X 7.3 X 3.0mm)

FEATURES

- Alloy Powder Molding
- Low DCR
- Magnetic shielded
- Low acoustic noise
- Halogen Free RoHS compliant



SPECIFICATION

Part No.	Inductance (μH)	Tolerance (%)	DC Resistance ($\text{m}\Omega$)		Rated DC Current (A) Typ.	
			Max. (Typ.)		$\Delta L/L=30\%$	$\Delta T=40^\circ\text{C}$
TMPIC07030F-R47M	0.47	$\pm 20\%$	4.1 (3.5)		20.0	18.0
TMPIC07030F-R68M	0.68	$\pm 20\%$	5.3 (4.8)		17.0	16.0
TMPIC07030F-1R0M	1.0	$\pm 20\%$	7.4 (6.7)		15.0	12.0
TMPIC07030F-1R5M	1.5	$\pm 20\%$	12.1 (10.6)		14.0	12.0
TMPIC07030F-2R2M	2.2	$\pm 20\%$	15.0 (13.5)		10.0	9.5
TMPIC07030F-3R3M	3.3	$\pm 20\%$	22.0 (18.0)		9.5	8.5
TMPIC07030F-4R7M	4.7	$\pm 20\%$	33.0 (28.0)		6.5	6.0
TMPIC07030F-6R8M	6.8	$\pm 20\%$	48.0 (42.5)		6.0	5.5
TMPIC07030F-100M	10	$\pm 20\%$	67.0 (62.0)		5.5	4.8
TMPIC07030F-220M	22	$\pm 20\%$	200 (180)		3.0	2.9

- Measurement frequency of Inductance value : at 100KHz, 1V
- Test equipment: CH1062A / CH1320

DIMENSION

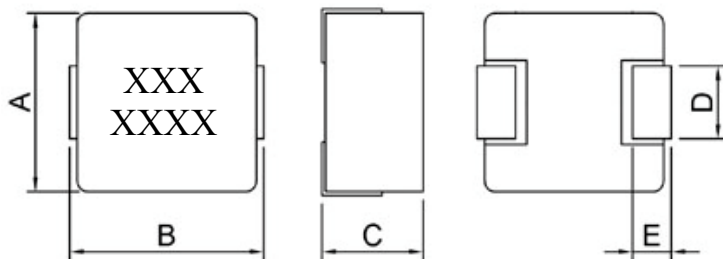

SOLDER PATTERN

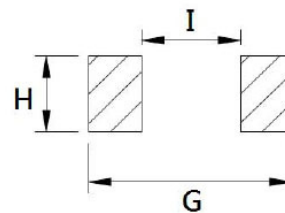

SCHEMATIC

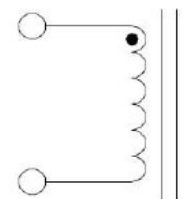

	A	B	C	D	E	G	H	I
mm	6.80 Max	7.30 Max	3.00 Max	3.00 ± 0.3	1.6 Ref	8.00 Ref	3.45 Ref	3.70 Ref

REEL DIMENSIONS (1500 pcs per reel)

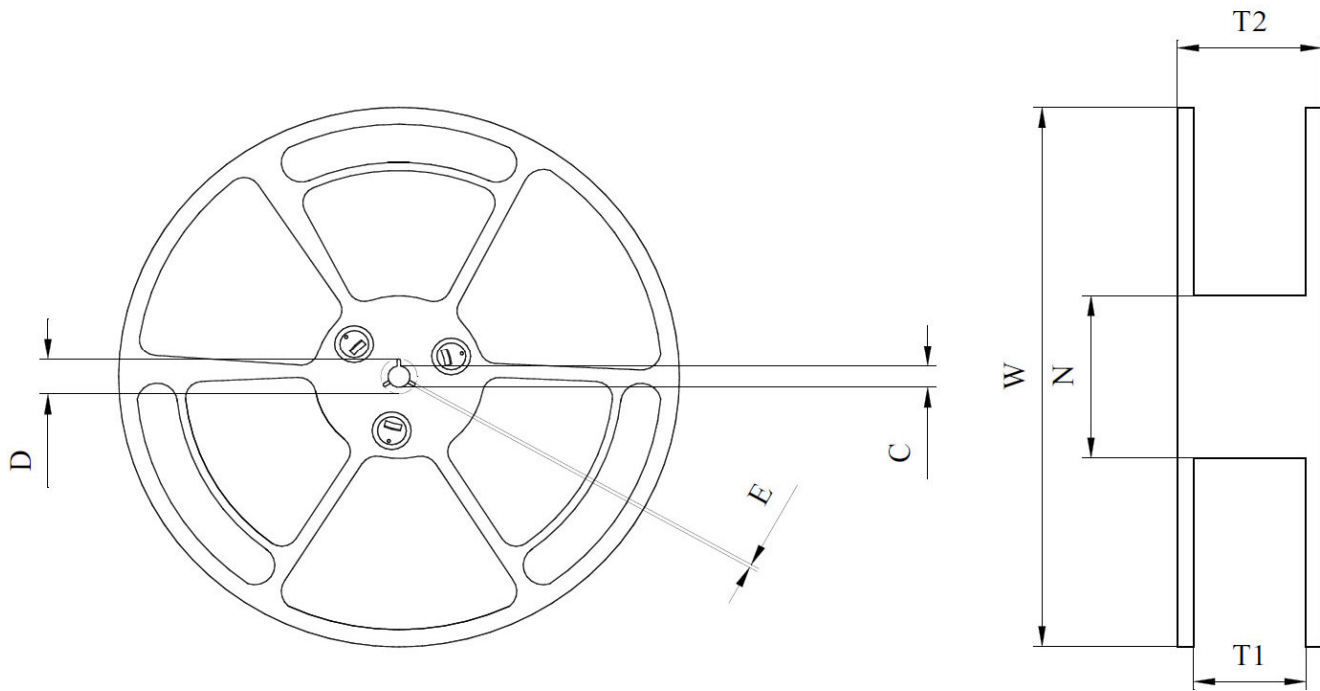

	W	D	C	T1	N	T2	E
mm	330 ± 1.5	$21.5 +0.5 / -0$	$13 +0.5 / -0.2$	$24.0 +0.5 / -0$	100 ± 1.5	26.0 ± 0.4	2.00 ± 0.5

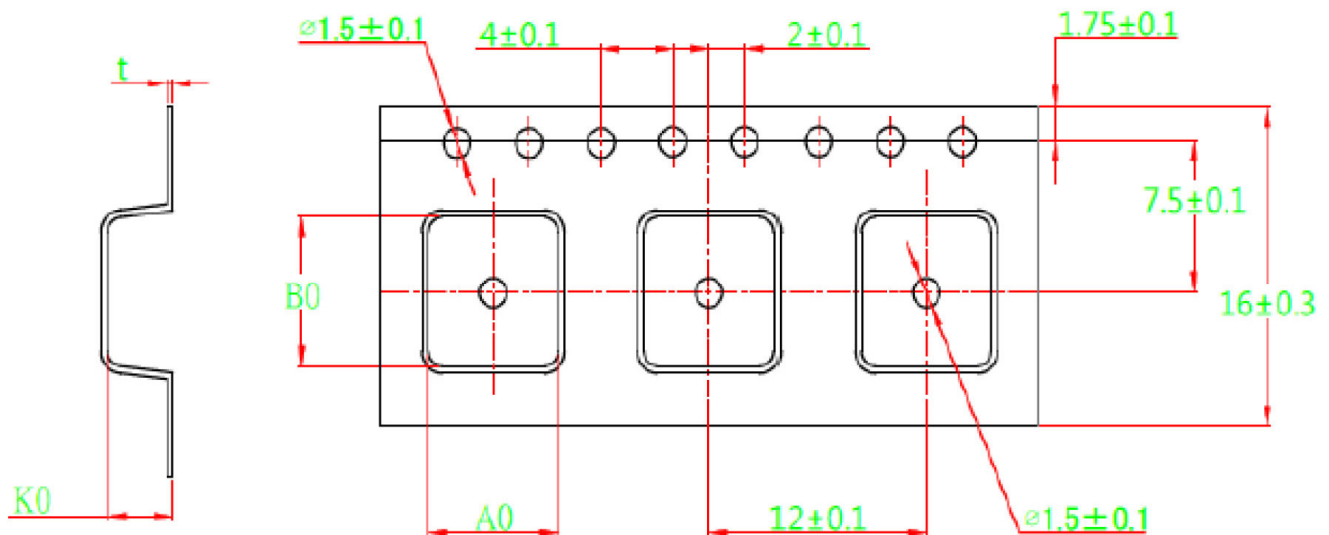

	A0	B0	K0	t		
mm	7.2 ± 0.10	7.5 ± 0.10	3.6 ± 0.15	0.35 ± 0.05		

RELIABILITY TEST

1. Operating temperature range
-55 TO + 125°C (Includes temperature when the coil is heated)
2. External appearance
On visual inspection, the coil has no external defects.
3. Terminal strength
After soldering. Between copper plate and terminals of coil. Push in two directions of X.Y withstanding at below conditions.
Terminal should not peel off. (refer to figure at right)
5.0N 60 sec.
4. Insulating resistance
Over 100MΩ at 100V D.C. between coil and core.
5. Dielectric strength
No dielectric breakdown at 100V D.C. for 1 minute between coil and core.
6. Temperature characteristics
Inductance coefficient $(0\sim 2,000)\times 10^{-6}/^{\circ}\text{C}$ (-25~+80°C)
inductance deviation within $\pm 5.0\%$, after 96 hours
7. Humidity characteristics (Moisture Resistance)
Inductance deviation within $\pm 5\%$, after 96 hours in 90~95% relative humidity at $40 \pm 2^{\circ}\text{C}$ and 1 hour drying under normal condition.
8. Vibration resistance
Inductance deviation within $\pm 5\%$, after vibration for 1 hour. In each of three orientations at sweep vibration (10~55~10 Hz) with 1.5mm P-P amplitudes.
9. Shock resistance
Inductance deviation within $\pm 5\%$, after being dropped once with 981m/s^2 (100G) shock attitude upon a rubber block method shock testing machine, in three different orientations.
10. Resistance to Soldering Heat: 260°C, 10 seconds (See recommend reflow)
11. Storage environment
Temperature: 0°C~35°C; -55°C~125°C (after mounting on PCB)
Humidity Range: 50% ~ 70% RH
12. Use components within 12 months.
If 12 months or more have elapsed, check solderability before use.

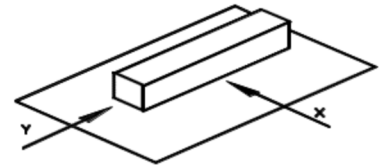

LEAD-FREE HEAT ENDURANCE TEST

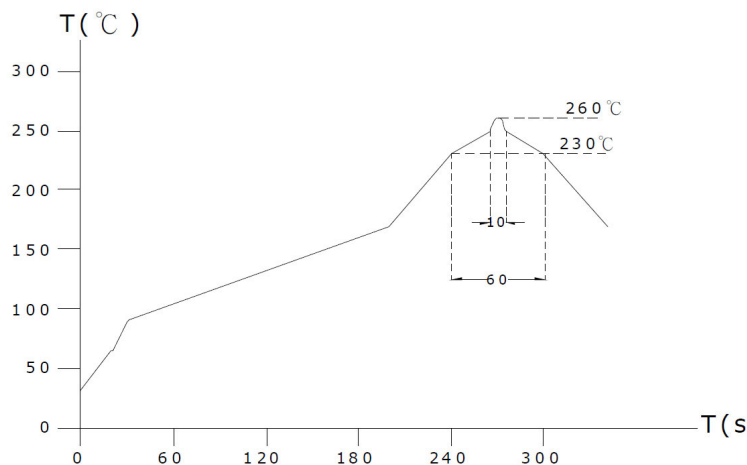

LEAD-FREE RECOMMENDED REFLOW

